

1 **Planta de Localização**
1 : 50

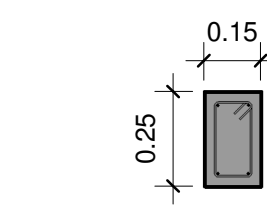

9 **V5=V6=V7 - Central GLP**
1 : 20

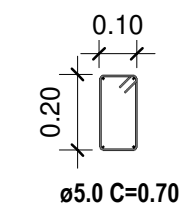

10 **Estribos V5=V6=V7 - Central GLP**
1 : 20

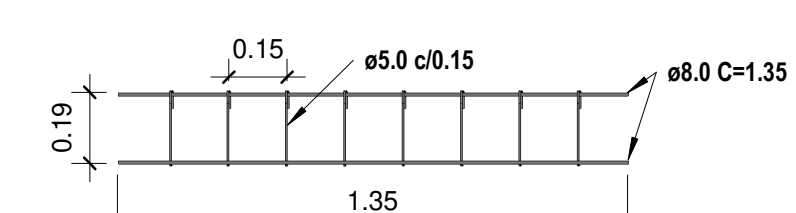

11 **V5 - Central GLP**
1 : 20

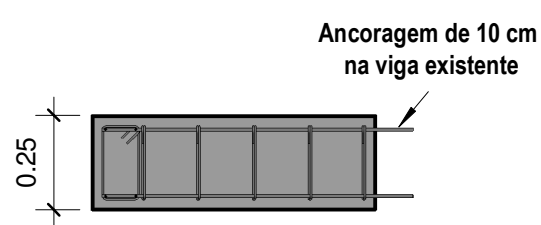

12 **Concreto V6=V7 - Central GLP**
1 : 20

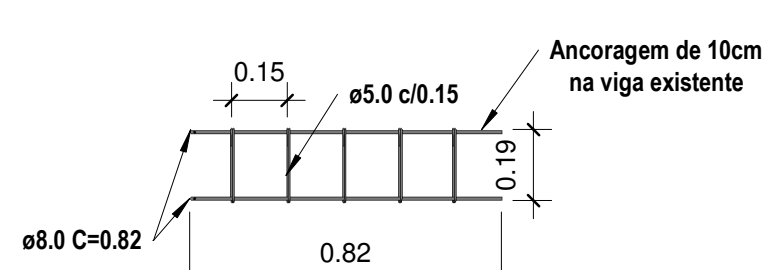

13 **V6=V7 - Central GLP**
1 : 20

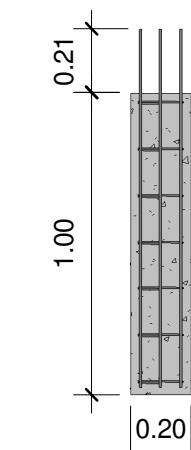

14 **Concreto E1=E2=E3**
1 : 25

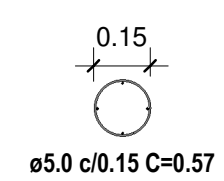

16 **Estribos E1=E2=E3**
1 : 20

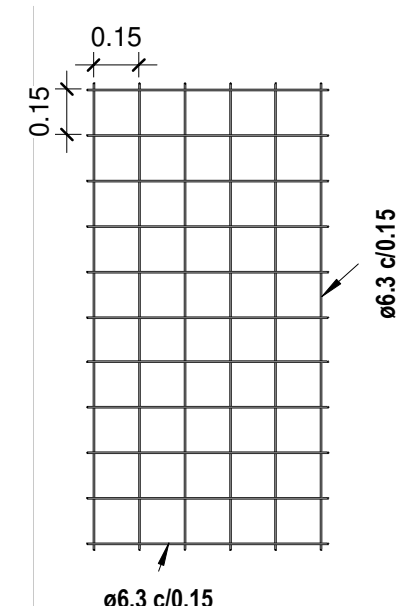

18 **Armadura Laje - Central GLP 01**
1 : 25

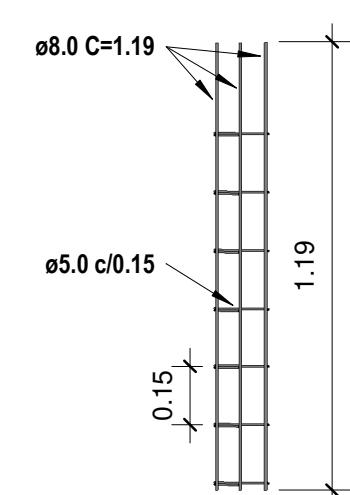

15 **E1=E2=E3**
1 : 20

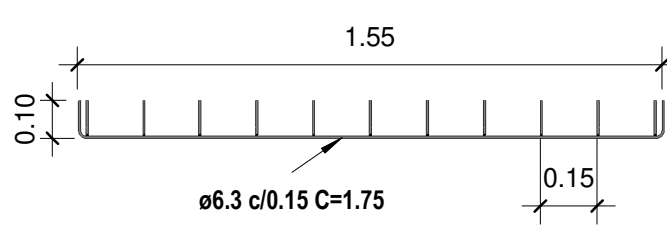

19 **Armadura da Laje - Central GLP 02**
1 : 20

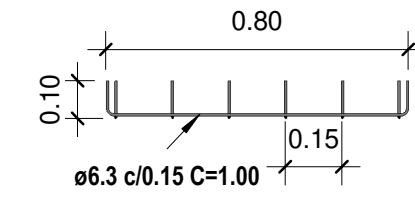

20 **Armadura da Laje - Central GLP 03**
1 : 20

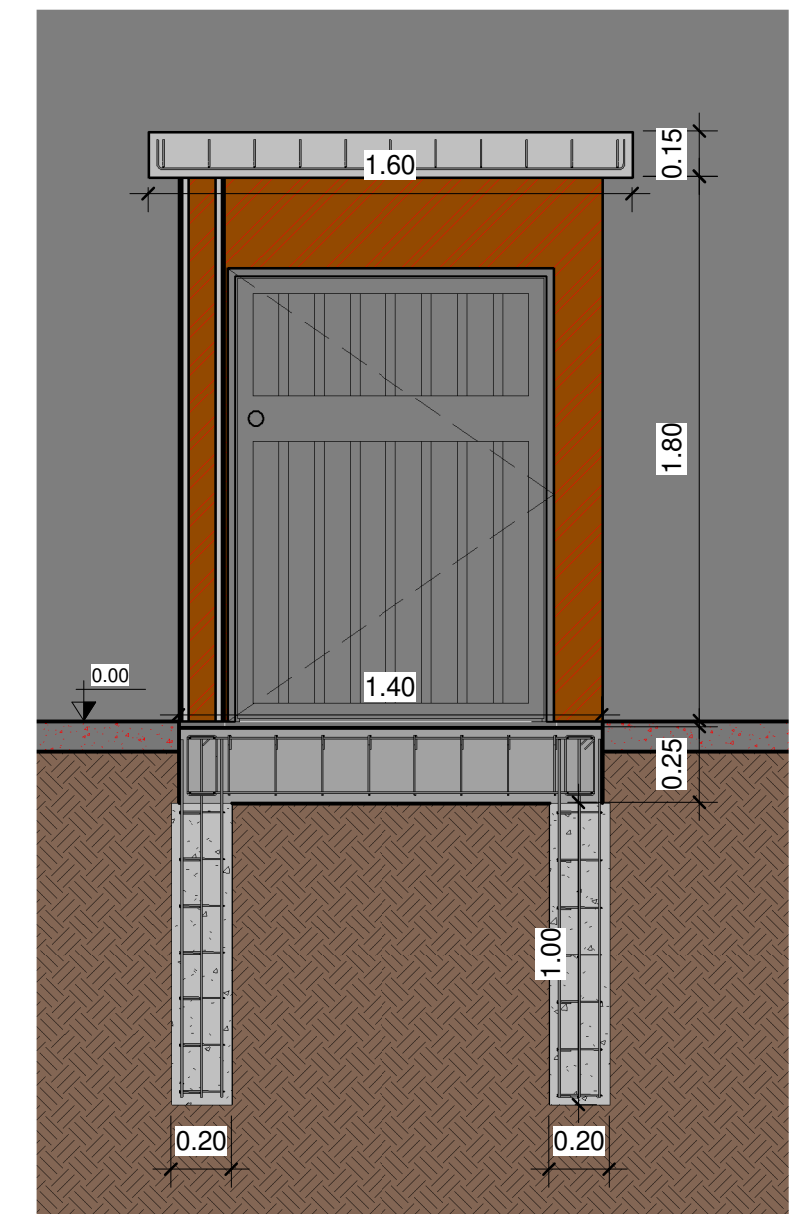

8 **Vista frontal - Central GLP**
1 : 25

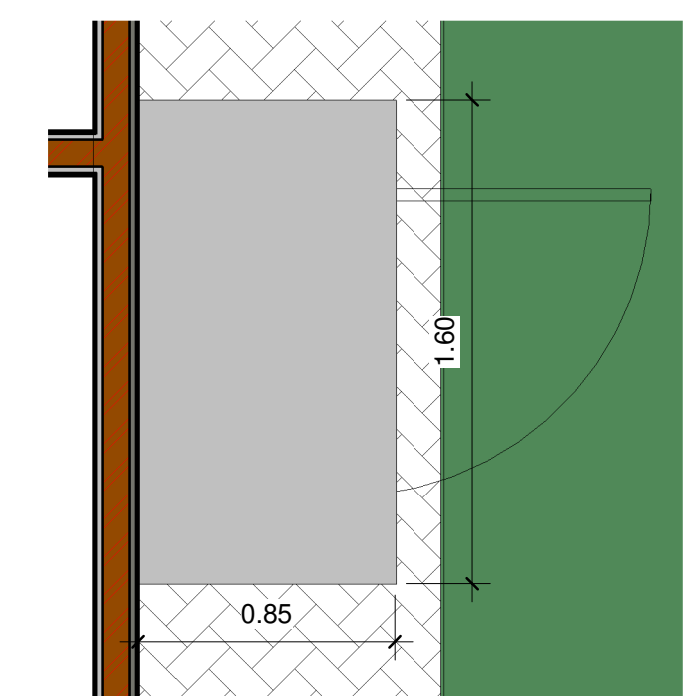

17 **Laje - Central GLP**
1 : 25

V - Viga Valdrame
S - Sapata Corrida
E - Estaca Central GLP/ Gradil Nylonfor3D
Legenda
1 : 50

		PREFEITURA DO MUNICÍPIO DE SANTA CECÍLIA ENGENHARIA E PROJETOS R. JOÃO GOETTEN SOBRINHO - CENTRO SANTA CECÍLIA, SC FONE: (49) 3244-2032	
Título: GINÁSIO DOS TRABALHADORES		Projeto: ESTRUTURAL	
Local da obra: Travessa José Calixtro, s/n		Data: 28/09/2023	
Engº Resp. Projeto: Luciano Rosa dos Santos Eng. Civil CREA/SC 156118-9		Escala: Indicada Desenhista: Luciano R. S. Construir (m²): 1141,2	
Proprietário/Responsável: NOME: Alessandra Aparecida Garcia CNPJ: 85.997.237/0001-41		Terreno (m²): 2250,3 Folha: 01/04	